

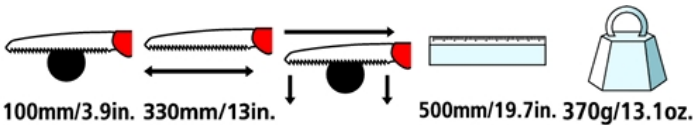

## FELCO 611 - Green

Pull-stroke Pruning saw - Pull-stroke pruning saw - Blade 33 cm (13 in.)

Designed in Switzerland by FELCO, Made in South Korea, Guaranteed FELCO Quality, PATENT NO: US D500,656 S



- > **Reliable:** rust resistant chromed blade made of steel / impulse heat treatment of the teeth / clean, precise cut / parts can be replaced
- > **Efficient:** conical blade shape for an easy, non-clogging cut / the set and shape of the teeth prevents sap build-up / maintenance free
- > **Ergonomic:** comfortable non-slip handle / sheath for right- or left-handers with detachable belt loop



## RECOMMENDED FOR

Our recommendation (★ = Recommended, ★★ = Strongly recommended, ★★★ = Best fit)

Viticulture	★★★
Arboriculture	★★★
Parks and Gardens	★★★
Small hand	★★★
Average-sized hand	★★★
Large hand	★★★
Right-handed	★★★
Left-handed	★★★

---



## THE POINTS OF EXCELLENCE



### **Pull-stroke**

The pull-stroke technique reduces effort and eliminates the risk of the blade pig-tailing.



### **Anticorrosion**

Rust resistant chromed blade made of steel.



### **Cutting edge durability**

Teeth are submitted to the impulse treatment in order to increase the durability of the saw's cutting edge.



### **Teeth geometry**

The teeth geometry is particularly suited for cutting woodland. Improved clearance of metal shavings and a softer bite in order to avoid arm injuries/aches and pains.



### **Blade geometry**

The shape of the long blade guarantees optimal comfortable working conditions and reduces vibrations.



### **Ergonomics**

The ergonomic, non-slip handle provides good handling.



### **Sheath included**

It is equipped with a detachable belt loop which allows you to wear the saw on the belt. Suited to both right-handers and left-handers.









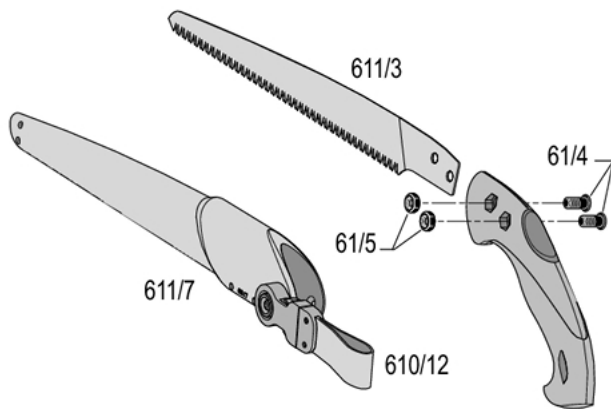

## ACCESSORIES



FELCO 980  
Maintenance product  
Spray

## SPARE PARTS



FELCO	REF.	Designation	Composition	UCC Barcode
	611/3	Blade	1x 611/3	 7 83929 40111 9
	61/4	Screw	1x 61/4	 7 83929 40227 7
	61/5	Nut	1x 61/5	 7 83929 40228 4
	610/12	Flange	1x 610/12	 7 83929 40229 1
	611/7	Holster	1x 611/7	 7 83929 40231 4



## PARTS REPLACEMENT



### **Changing the blade**

If the tool is no longer cutting properly, it is advisable to change it.